

User's Instructions

Condensing gas boiler

Logamax plus GB162- L.B. 80 kW/100 kW



Buderus

This manual is available in the English and French language.

This manual must be retained for future use.

Please read thoroughly before operating

Warning: If the information in these instructions is not followed exactly, a fire or explosion may result causing property damage, personal injury or loss of life.

- **Do not store or use gasoline or other flammable vapors and liquids in the vicinity of this or any other boiler.**
- **What to do if you smell gas**
 - **Do not try to light any boiler.**
 - **Do not touch any electrical switch; do not use any phone in your building.**
 - **Immediately call your gas supplier from a neighbor's phone. Follow the gas supplier's instructions.**
 - **If you cannot reach your gas supplier, call the fire department.**
- **Installation and service must be performed by a qualified installer, service agency or the gas supplier.**

CAUTION !

The operating manual is part of the documentation that is delivered to the installation's operator. Go through the information in this manual with the owner/operator and make sure that he or she is familiar with all the necessary operating instructions.

Contents

1	For your safety	5	4	Starting up the boiler	18
1.1	Designated use	5	4.1	Boiler settings	18
1.2	Safety instructions	6	4.2	Check the system pressure	19
1.3	Quality of the heating system water	8	4.3	Fill the heating system	20
2	Lighting Instructions	9	4.4	Frost protection	23
3	Operating the BC10 basic controller 10		5	Shutting down the boiler	24
3.1	General	11	6	Operating and error messages	25
3.2	Switching ON and OFF	11	6.1	Normal operation menu	25
3.3	Setting the DHW temperature value	12	6.2	Manual Operation menu	26
3.4	Setting the space heating water temperature	15	6.3	Settings menu	28
3.5	"Burner ON" LED	17	6.4	Display codes	31
3.6	Other functions and economic heating	17	6.5	Identifying and resetting faults	34

Preface

About these instructions

These user's Instructions contain important information for the safe and proper operation of Logamax plus GB162-80kW/100kW condensing gas boilers.

If the information in this manual is not followed exactly, a fire or explosion may result causing property damage, personal injury or loss of life.

Subject to technical changes!

Changes may be made following technical improvements!

Updating of documentation

Please contact us if you have any suggestions for improvements or corrections.

1 For your safety

Logamax plus GB162 condensing gas boilers are designed and built according to the latest technological advances and safety requirements.

The design is specifically focused on ease of use. To ensure the safe, economical and environmentally friendly use of the heating system we urge you to read and observe the User's Instructions.

1.1 Designated use

The boiler was designed for heating water for a central heating system and generating domestic hot water. The boiler can be installed either as a single system or as part of a multiple system (cascade system) with a maximum of 8 boilers connected together.

Hazard definitions



DANGER

Indicates the presence of hazards that will cause severe personal injury, death or substantial property damage.



WARNING

Indicates the presence of hazards that can cause severe personal injury, death or substantial property damage.



CAUTION

Indicates presence of hazards that will or can cause minor personal injury or property damage.



CAUTION

Risk of electric shock.
Indicates presence of hazards due to electric shock.

**NOTICE**

Indicates special instructions on installation, operation or maintenance that are important but not related to personal injury or property damage.

1.2 Safety instructions

Make sure to observe these safety instructions. Failure to do so can result in property damage, personal injury or loss of life.

- Installation, gas and flue connection, commissioning, electrical connection and maintenance activities must only be carried out by a trained service provider.
 - Certain work, e.g. on gas lines, may require a professional license. Only carry out such work if you are licensed to do so.
 - Only use the boiler for its intended purpose and only when it is in working order.
- Have a trained service provider check, clean and service the heating system once a year. Buderus recommends a contract for annual service and maintenance.
 - The condensate collection and disposal system must be periodically cleaned by a trained service technician.
 - Have your trained service provider give you detailed instructions about the operation of the heating system.
 - Carefully read these user's instructions.
 - Immediately have all defects to the heating system repaired.
 - Ensure that air intake and outlet openings are open and free from obstructions at all times.

- Do not store any flammable material or liquids in the immediate vicinity of the boiler.
- Never use chlorinated detergents or halogenated hydrocarbons (e.g. in spraycans, solvents and detergents, paints, adhesives) in the room where the boiler is installed.
- When Calcium Chloride is present in concrete floors (when poured in winter) it is necessary to seal the floor with a suitable paint.
- Do not allow too much dust to collect on the device.
- Do not use the boiler if any part has been under water. Immediately call a trained service technician to inspect the boiler and to replace any part of the control system and any gas control which has been under water.
- Should overheating occur or the gas supply fails to shut off, do not turn off or disconnect the electrical supply to the pump. Instead, shut off the gas supply at a location external to the boiler.
- The venting system must be inspected annually. Replace any parts which show deterioration from corrosion or any other sources.
- This boiler does not have a pilot. It has an ignition device which automatically lights the burner.
- Check for smell of gas around the boiler area. Be sure to smell next to the floor because propane gas is heavier than air and will settle on the floor.
- Use only your hand to turn the gas control knob (fig. 4 on page 18). Never use tools. If the knob will not turn by hand, don't try to

repair it, call a trained service technician. Force or attempted repair may result in a fire or an explosion.

- When the vent system is blocked, this boiler will shut off automatically with code '3C'. Immediately call a trained service technician to inspect and reset the boiler.

1.3 Quality of the heating system water

Use only untreated tap water when filling or topping up the heating system. The use of unsuitable heating system water will lead to build-ups of sludge and corrosion, which can in turn result in the malfunctioning of the boiler and damage to the heat exchanger.

DO NOT treat the water with products such as pH-adjusting substances (chemical additives) and antifreeze or water softeners.

2 Lighting Instructions



STOP!

Read the chapter "For your safety" on page 5 before lighting the boiler.

- Follow the instructions to start up the boiler in "Starting up the boiler" on page 18.

3 Operating the BC10 basic controller

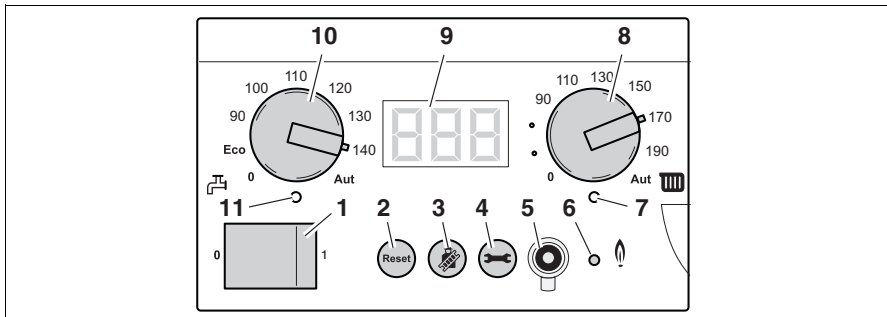

Fig. 1 Logamatic BC10 basic controller – Controls

- | | | |
|---------------------------|---|--------------------------|
| 1: Main power switch | 5: Service Tool connector | 9: Display |
| 2: "Reset" button | 6: LED "Burner operation" | 10: DHW temperature knob |
| 3: "Chimney sweep" button | 7: LED "Heating system status" | 11: LED "DHW status" |
| 4: "Service" button | 8: Space heating water temperature knob | |

3.1 General

The boiler is equipped with a control unit, the BC10 basic controller (fig. 2). This controller can be used to control the heating system.



NOTICE

If your heating system consists of several boilers (cascade system), you have to carry out the settings on the control units of all individual boilers.

- Push on the control panel to open it (fig. 2) and get access to the controller.

3.2 Switching ON and OFF

- Set the main switch on the BC10 to position "1" (ON) to switch ON the boiler and set it to "0" to switch the boiler OFF.

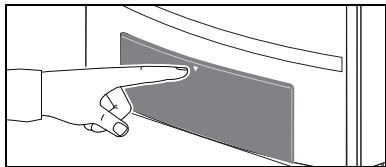

Fig. 2 Opening the control panel



**CAUTION**

Risk of electric shock.

If a hazardous situation occurs, shut OFF power to the boiler using the emergency shutoff switch or the boiler circuit breaker (see chapter 4 "Starting up the boiler", page 18). Make yourself familiar with the location of the emergency shutoff switch and the boiler loop circuit breaker.

3.3 Setting the DHW temperature value

- Check the local code for the max. DHW temperature.
- Turn the "DHW temperature" rotary knob to set the desired temperature of the hot water in the DHW tank.

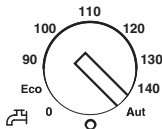

	Condition	Explanation	LED
0	OFF	No hot water supply (only heating mode).	OFF
Eco ¹	Economy mode, Hot water temperature 140 °F (60 °C)	The DHW will only be reheated to 140 °F (60 °C), if the temperature has significantly fallen. This reduces the number of burner starts and saves energy. As a result the water may be a bit cooler initially.	ON ²
86 – 140	Direct setting on BC10 in °F	The temperature set on the BC10 is a fixed temperature that cannot be changed using a RC thermostat.	ON ²
Aut	Entry via thermostat (presetting)	The temperature setting defaults to the maximum DHW temperature of 140 °F (60 °C).	ON ²

Tabel 1 Settings of "DHW temperature" knob

¹ This function has been optimized for boilers with combined DHW heating (combi-units).

² The LED under the rotary knob lights if the DHW temperature is below the target value (heat request for DHW).

Anti-scald table

Temperature of water	Minimum time for first degree burn	Minimum time for second or third degree burn
111 °F (44 °C)	5 hours	7 hours
116 °F (47 °C)	35 minutes	45 minutes
118 °F (48 °C)	10 minutes	14 minutes
122 °F (50 °C)	1 minute	5 minutes
131 °F (55 °C)	5 seconds	25 seconds
140 °F (60 °C)	2 seconds	5 seconds
149 °F (65 °C)	1 second	2 seconds
158 °F (70 °C)	–	1 second

Table 2 Temperature/Time/Burn Chart

3.4 Setting the space heating water temperature

- Turn the "space heating water temperature" knob to set the upper limit value of the heater water for the heating operation. This limitation does not apply to DHW preparation.

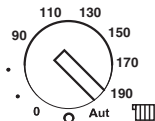

	Condition	Explanation	LED
0	OFF	No supply to heating system (only DHW heating operation).	OFF
86 – 190	Direct setting on BC10 in °F	The temperature set on the BC10 acts as a high limit. With a AM10 or RC10 control, the water temperature will be at a equal or lesser value. With a On/Off thermostat the water temperature will always be the set temperature. Supply temperature never rises above the set temperature.	ON ¹
Aut	Entry via thermostat (presetting)	The temperature high limit setting defaults to the maximum boiler water temperature of 190 °F (90 °C).	ON ¹

Tabel 3 Settings of "space heating water temperature" rotary knob

- ¹ The LED under the rotary knob lights when the heating system is switched ON and heat is requested. In summer mode the heating system is switched OFF (LED OFF).

3.5 "Burner ON" LED

The LED indicates the operating condition of the burner.



LED	Condition	Explanation
ON	Burner active	The water in the boiler is being heated.
OFF	Burner OFF	The water in the boiler has reached the required temperature or there is no heat request.

Tabel 4 LED indication

3.6 Other functions and economic heating

The functions described above are basic functions, carried out directly on the boiler using the BC10 basic controller.

4 Starting up the boiler

4.1 Boiler settings

- Turn the "space heating water temperature" and "DHW temperature" rotary knobs to "Aut" (automatic mode).

The control unit will now take control.

- Slowly open the gas valve by pushing on the gas valve and turning it $\frac{1}{4}$ rotation in an counterclockwise direction (fig. 3, pos. 1). The gas valve is open when it is in its vertical position.
- Open the pump group isolating valves (fig. 3, pos. 2).

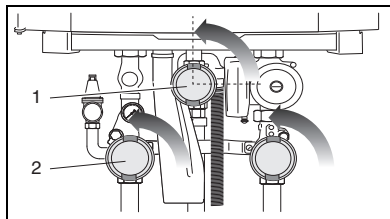
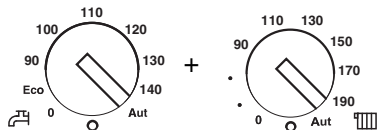

Fig. 3 Opening gas- and isolating valves

- Set the main switch on the basic controller to position "1" (ON). The basic controller checks the current system status and the burner becomes operational as soon as there is a heat request. This procedure takes approx. 30 seconds.
- Adjust the settings on the control unit (see the Operating Instructions for the control unit).



4.2 Check the system pressure

If the heating system has just been filled, the system pressure must initially be checked every day, for 1 week.

The maximum pressure in the heating system, measured directly at the boiler, must not exceed 51 psi (3.5 bar).

- Press the "Service" button (fig. 1, pos. 4) until the system pressure ("P22") is shown in the display (pos. 9).

- Fill the heating system if the system pressure has dropped below 15 psi (1.0 bar) according to paragraph “Fill the heating system” on page 20.

4.3 Fill the heating system

- Remove the lower casing from the pump group (fig. 4).

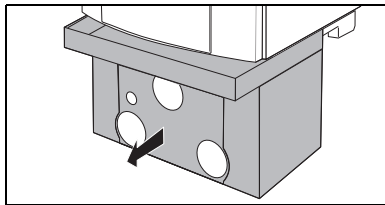

Fig. 4 Removing the lower casing

- Unscrew the sealing cap (fig. 5).

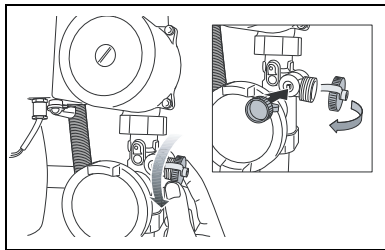

Fig. 5 Removing cap from drain cock

- Fill the heating system to a pressure of appx. 20 psi (1.5 bar). Read the pressure from the pressure gauge on the pump group or on the control panel of the BC10 (fig. 6).

The pressure in the heating system, which is measured directly at the boiler, must be at least equal to the required pre-pressure of the expansion vessel plus 7 psi (0.5 bar). The minimum pressure must not be less than 15 psi (1.0 bar) (if the heating system is cold). The maximum pressure in the heating system must not exceed 50 psi (3.5 bar).

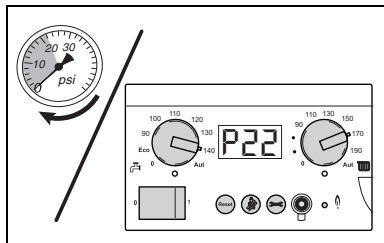

Fig. 6 Reading the pressure gauge



NOTICE

It is very important that the heating system is now purged, since all air will collect at the highest point of the heating system when the system is slowly filled with water.

- Purge the heating system via the air vents/valves on the heating bodies. Start at the first floor of the premises and then work your way up (fig. 7).

The pressure loss in a heating system is caused by air bubbles escaping via fittings and (automatic) air vents. The oxygen contained in the fresh heating water will also escape from the heating water after some time and cause a pressure loss.

Topping up once a year is normal. If it is necessary to top up more frequently, there might be a leak in the system or a defective expansion vessel. This must be remedied as soon as possible.

4.4 Frost protection

When switched on, the boiler has an integrated frost protection system. This means that no further frost protection facilities should be installed on the boiler.

The frost protection switches the boiler on at a flow temperature of 45 °F (7 °C) and off at a flow temperature of 59 °F (15 °C). The heating system itself is not protected against frost.

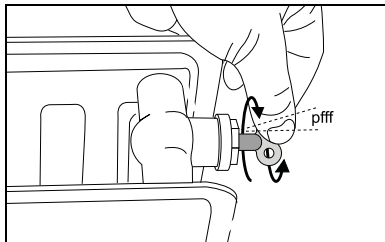

Fig. 7 Purging a radiator (example)

5 Shutting down the boiler

- Set the main switch on the basic controller to position "0" (OFF).
- Close the gas shut-off valve and disconnect the boiler from the power supply.



DANGER

The heating system may freeze if it is not operational in times of freezing weather.

- Protect the heating system against freezing if there is a danger of frost affecting the system.
- Drain the heating system water from the lowest point of the heating system using the boiler filling and draining cock. The vent screw at the highest point of the heating system must then be open.

6 Operating and error messages

In normal operating mode, the display shows the current heater water temperature. You can display other information using the "Service" button. Also see section 6.4.

- Push the "Service" button (pos. 4) a number of times to switch between the various status displays.

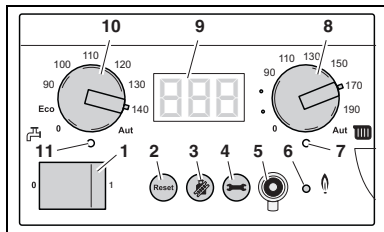





Fig. 8 Basic controller BC10

6.1 Normal operation menu

Normal Operation menu	
	24 Shows currently measured space heating water temperature in °F.
	P22 Shows currently measured system pressure in psi.
	-H Current display code. In this case: Operating phase: Boiler in heating mode.

Tabel 5 Normal operation



6.2 Manual Operation menu

In manual mode, the heating system can be operated independent of a room controller (e. g. RC35).





NOTICE

- Re-start manual operation after switching on the heating system, so that the system is permanently in operation (especially if there is a risk of freezing).

Manual Operation menu	
	To activate manual operation: Press and hold the  button for more than 5 seconds.
	<div style="border: 1px solid black; padding: 2px; display: inline-block; margin-right: 5px;">24</div> A flashing dot in the right-hand bottom corner of the display shows manual operation is active. This means that the boiler is permanently in heating mode: <ul style="list-style-type: none"> – Space heating water temperature is as set on the BC10 basic controller. – The LED "Heating system status" lights. – DHW mode is possible during manual operation.
	<div style="border: 1px solid black; padding: 2px; display: inline-block; margin-right: 5px;">P 1.6</div> Shows currently measured P system pressure in psi(pounds per square inch).

Tabel 6 Manual operation

Manual Operation menu	
	<div data-bbox="175 215 270 252" style="border: 1px solid black; padding: 2px; display: inline-block;">-H</div> Display code: Operating phase: Also see section 6.4. The boiler is in manual operation mode. During manual operation the "Settings" menu (table 7 from step 2) can be used to temporarily change the target boiler performance. Notice: If the boiler output has been changed temporarily, this must be set again after ending manual operation, according to the "Settings" menu (table 7).
	<div data-bbox="175 422 270 459" style="border: 1px solid black; padding: 2px; display: inline-block;">24</div> Shows currently measured space heating water temperature in °F.
	After a power interruption manual operation ends automatically. To end manually press and hold the  button for more than 2 seconds until the dot disappears.

Tabel 6 Manual operation (continued)

6.3 Settings menu

Three settings can be made in the Settings menu:





- Modulation rate
- Post purge time
- DHW mode (On/off).



NOTICE















The modulation rate and the DHW mode should be set by a trained installer.

If you will be on vacation for a long period while there is a risk of freezing, the post purge time will have to be set (section 4.1 on page 18).









Settings menu	
	To open the "Settings" menu: Press and hold the  +  buttons for more than 2 seconds.
	 This shows the "Settings" menu is open. You can adjust the setting of this parameter.

Tabel 7 Settings

Settings menu

	<p> modulation rate. Adjust as follows, or press :</p> <p>Lower: Decrease the modulation rate with the  button. The minimum setting is  = 36 % with an 80-kW boiler and  = 30 % with a 100-kW boiler.</p> <p>Higher: Increase the modulation rate with the  button. The maximum setting is  = 100 %. This is equal to the factory setting.</p>
	<p> Pump run-over time in minutes (starts when the heating mode has ended). Adjust as follows or go to the next step:</p> <p>Lower: Decrease the time with the  button.</p> <p>The minimum setting is  = 0 minutes. The factory default setting is 5 minutes.</p> <p>CAUTION Do not set the post purge time to less than 5 minutes.</p> <p>Higher: Increase the time with the  button.</p> <p>The maximum setting is  = 60 minutes or  = 24 hours.</p>





Tabel 7 Settings (continued)

Settings menu	
	<p> DHW mode status setting. Adjust as follows, or press :</p> <p>DHW mode can be switched OFF or ON. This setting has priority over other DHW mode settings, such as those made on the room thermostat.</p> <p>Set the DHW mode with the  or  buttons.  means "ON",  means "OFF".</p> <p>NOTE: Setting  also switches OFF the hot water cylinder frost protection.</p>
	<p>After 5 seconds or after a power interruption the settings menu ends automatically. To end manually press the  button.. Any adjustments that you have made have been confirmed.</p>

Tabel 7 Settings (continued)







6.4 Display codes

The display shows the condition of the boiler with a code. The table below shows normal operation codes. If a different code shows, please refer to section 6.5, "Identifying and resetting faults" on page 34 .

Display codes	
	Communication test while starting up.
 dot	Any display code with a dot in the bottom right-hand corner. The boiler is in flue gas test or service mode.
	The boiler is in heating mode.
 flashing dot	Any display code with a flashing dot in the bottom right-hand corner. The boiler is in manual operation mode.

Tabel 8 Display codes

Display codes

	<p>The boiler is in DHW (domestic hot water) mode, or</p> <p>The boiler is in pump run-over time via the external hot water cylinder 130 seconds at the minimum speed. The "Burner" LED (On/Off) is off.</p>
	<p>Boiler interval circuit.</p> <p>The boiler cannot start-up more than once every 10 minutes. This program is activated if there has been a DHW request from an RC regulator more frequently than once every 10 minutes.</p>
	<p>The boiler prepares for a burner start-up.</p> <p>There is a current heat demand or a DHW request.</p>
	<p>The boiler is standby.</p> <p>There is a current heat demand, but too much energy has been supplied.</p>
	<p>The boiler is standby. There is no current heat demand.</p>
	<p>Ignition phase. The gas valve is activated.</p>

Tabel 8 Display codes (continued)

Display codes

0U	Start-up phase. The boiler starts up after activation of the main power supply or completion of a system reset.
0Y	The flow temperature is higher than set.
2E	Fault (subcode 207). The system pressure is too low (less than 3 psi (0.2 bar)).
888	Display test during start-up phase (max. 1 second).
H 7	The system pressure is too low (less than 12 psi (0.8 bar)).
H 7	The system pressure is too low (less than 12 psi (0.8 bar)).
P	The system pressure is too high (higher than 58 psi (4.0 bar)).
rE	The boiler is resetting.

Table 8 Display codes (continued)

6.5 Identifying and resetting faults

If a fault occurs, the error code flashes ON and OFF on the display of the BC10 basic controller.

- Push the "Reset" button for approx. 5 seconds to reset the fault.

The display shows "rE" while resetting. Reset is only possible if there is a flashing error message.

If the display then shows a normal operation message from tabel 8, this means that the fault has been remedied. If the fault recurs, you must repeat resetting two or three more times.

If the fault cannot be reset:

Write down the error message and contact your heating equipment service company.

Make sure that the heating system is not damaged by frost (see the safety instructions in chapter "Shutting down the boiler" on page 24).





Buderus

Bosch Thermotechnology Corporation
50 Wentworth Ave
Londonderry, NH 03053
Tel: (603)-552-1100 Fax: (603)-421-2719
Toll Free: 1-800-BUDERUS
www.buderus.net

6720646148 0002

